

DE

i



Systembeschreibung komplexe
Einwandiges Edelstahlschornsteinsystem

12
GARANTIE
Jahre



schornsteinmarkt[®] Die ganze Welt des Feuers

■ Hersteller

eka Edelstahlkamine GmbH
Robert-Bosch-Straße 4
95369 Untersteinach

■ Anwendungsbereich

Kamine, Kaminöfen,
Kachelöfen, BHKW,
Backöfen, Brennwertgeräte,
Niedertemperaturanlagen

■ Betriebsweise

Unterdruck

feuchtunempfindlich bis 600 °C

Überdruck (mit Dichtungen)

druckdicht bis 200 °C

■ Kombination

Die starren Bauteile lassen sich bis 200 mm Durchmesser über Adapter mit dem flexiblen Edelstahlsystem kombinieren. Die flexible Schornsteinanlage ist für den feuchteunempfindlichen Betrieb ausgelegt. Es können alle Feuerstätten (feste, gasförmige, flüssige Brennstoffe) im Unterdruck betrieben werden.

■ Technische Eigenschaften

■ Werkstoffe

starre Bauteile:

1.4404 (V4A Edelstahl)
1.4571 (V4A Edelstahl)

flexible Bauteile:

1.4404 (V4A Edelstahl)
1.4436 (V2A Edelstahl)

■ Materialstärke

starre Bauteile:

0,6 mm

Materialstärke 1,0 mm
auf Anfrage

flexible Bauteile:

einlagig: 0,12 mm
doppellagig: 2x 0,12 mm



■ Oberfläche

matt

■ Wärmedurchlass

0,12 W/m²K

■ Temperaturklassen

feuchteunempfindlich:

T600 (bis 600 °C Abgastemp.)

druckdicht:

T200 (bis 200 °C Abgastemp.)

Russbrandbeständigkeit:

ja (bis 1000 °C Ausbrandtemp.)

■ sonstige Eigenschaften

Tiefe der Einsteckmuffen: 80 mm
Dichtigkeitsklasse: (feuchteunempfindlich): N1 = 40 Pa
Dichtigkeitsklasse: (druckdicht): H2 = 5000 Pa
Kondensatbeständigkeit: W (feucht)
Korrosionswiderstand: V2/ V3
Mittlere Rauigkeit des Edelstahlmaterials: 1,0 mm
Frost-/ Tauwechselbeständigkeit: ja

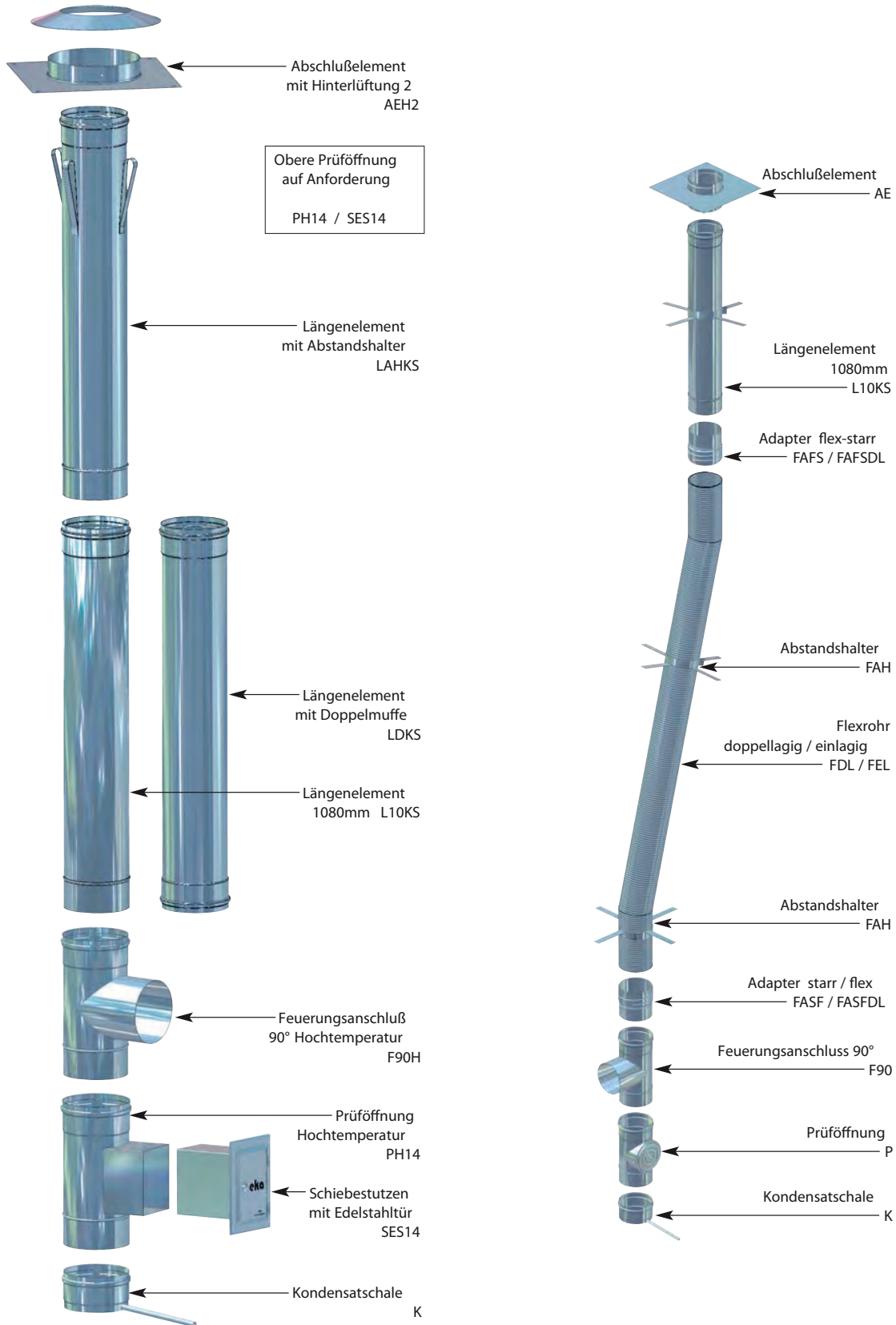

**Gewichts- und Flächenangaben**

Querschnitt/ mm	80	100	113	120	130	140	150	160	180	200	225	250	300	350	400	
Fläche in cm ²	50	79	100	113	130	154	177	201	255	314	398	491	707	962	1256	
Gewicht kg/m																
Starre Bauteile	0,6 mm	1,2	1,7	1,8	1,9	2,0	2,3	2,4	2,6	2,9	3,2	3,7	4,0	4,8	5,7	6,5
	1,0 mm	-	-	3,1	3,5	3,8	3,9	4,0	4,7	5,0	6,1	6,8	8,2	9,1	10,6	12,0
Flexible Bauteile	0,12 mm		0,55	0,60	0,65	0,70	0,75	0,80	0,85	0,95	1,05					
	2x0,12 mm		0,90	1,00	1,05	1,10	1,20	1,30	1,40	1,60	1,75					



Kondensatschale mit Ablauf K	ø d	a
	80	290
	100	300
	113	303
	120	310
	130	315
	140	320
	150	325
	160	330
	180	340
	200	350
	225	350
	250	375
	300	400
	350	425
	400	450
	450	475
	500	500
	600	550

Darstellung druckdichte Ausführung, sonst 70 mm hoch

Prüföffnung P / PVIT	ø d	a	b	ø c
	80	356	178	80
	100	356	178	100
	113	356	178	113
	120	356	178	120
	130	356	178	130
	140	356	178	140
	150	356	178	150
	160	356	178	160
	180	356	178	180
	200	356	178	200
	225	356	178	150
	250	500	250	180
	300	500	250	180
	350	500	250	180
	400	590	295	180
	450	590	295	180
	500	590	295	180
	600	590	295	180

Feuerungsanschluß 90° Niedertemperatur F90	ø d	a	b	c
	80	356	178	240
	100	356	178	250
	113	356	178	257
	120	356	178	260
	130	356	178	265
	140	356	178	270
	150	356	178	275
	160	356	178	280
	180	356	178	290
	200	356	178	300
	225	450	225	225
	250	450	225	235
	300	500	250	260
	350	550	275	285
	400	600	300	310
	450	650	325	335
	500	900	450	360
	600	1000	500	410

Feuerungsanschluß 45° F45	ø d	a	b
	80	395	240
	100	395	250
	113	395	257
	120	395	260
	130	395	265
	140	395	270
	150	445	300
	160	445	305
	180	445	315
	200	495	350
	225	545	370
	250	545	400
	300	645	475
	350	695	525
	400	800	580
	450	900	675
	500	1000	750
	600	1180	945

mit Kondensatabweiser

Prüföffnung Hochtemperatur PH12 PH14 PH15	ø d	12/18	14/20	15/30
	113	x	x	-
	120	x	x	-
	130	x	x	-
	140	x	x	-
	150	x	x	x
	160	x	x	x
	180	x	x	x
	200	x	x	x
	225	x	x	x
	250	x	x	x
	300	x	x	x
	350	x	x	x
	400	x	x	x
	450	x	x	x
	500	x	x	x
	600	x	x	x

mit Kondensatabweiser

x = gleich lieferbar

Feuerungsanschluß 90° Hochtemperatur F90H	ø d	a	b	c
	113	360	178	257
	120	360	178	260
	130	360	178	265
	140	360	178	270
	150	360	178	275
	160	360	178	280
	180	360	178	290
	200	360	178	300
	225	450	225	225
	250	450	225	235
	300	500	250	260
	350	550	275	285
	400	600	300	310
	450	650	325	335
	500	900	450	360
	600	1000	500	410

mit Kondensatabweiser

Feuerungsanschluß 90° mit Bajonettverschluß F90B	ø d	a	b	c
	80	360	178	240
	100	360	178	250
	113	360	178	257
	120	360	178	260
	130	360	178	265
	140	360	178	270
	150	360	178	275
	160	360	178	280
	180	360	178	290
	200	360	178	300

mit Kondensatabweiser

Wandfutter-Schiebeelement WS	Wandfutter WF

Längenelement 1080 mm
L10

auch mit kleiner Sicke erhältlich

Ø d
80
100
113
120
130
140
150
160
180
200
225
250
300
350
400
450
500
600

Rohre auch oval lieferbar (mit kleiner Sicke)

Längenelement mit Schlaufe
LS

auch mit kleiner Sicke erhältlich

Ø d
80
100
113
120
130
140
150
160
180
200
225
250
300
350
400
450
500
600

Rohre auch oval lieferbar (mit kleiner Sicke)

Längenelement mit Abstandshalter
LAH

auch mit kleiner Sicke erhältlich

Ø d
80
100
113
120
130
140
150
160
180
200
225
250
300
350
400
450
500
600

Rohre auch oval lieferbar (mit kleiner Sicke)

Längenelement mit Doppelmuffe
LD

auch mit kleiner Sicke erhältlich

Ø d
80
100
113
120
130
140
150
160
180
200
225
250
300
350
400
450
500
600

Rohre auch oval lieferbar (mit kleiner Sicke)

Längenelement 540 mm
L5

auch mit kleiner Sicke erhältlich

Ø d
80
100
113
120
130
140
150
160
180
200
225
250
300
350
400
450
500
600

Rohre auch oval lieferbar (mit kleiner Sicke).

Längenelement 360 mm
L3

auch mit kleiner Sicke erhältlich

Ø d
80
100
113
120
130
140
150
160
180
200
225
250
300
350
400
450
500
600

Rohre auch oval lieferbar (mit kleiner Sicke).

Abschlußelement
AE

Ø d	a
80	375
100	375
113	375
120	375
130	375
140	375
150	375
160	400
180	420
200	450
225	470
250	520
300	570
350	620
400	670
450	720
500	770
600	870

Ausführung ab Ø 225 siehe AEH2
Stutzen passend in Muffe

Abschlußelement mit Hinterlüftung
AEH bis Ø 200

Ø d	a
80	375
100	375
113	375
120	375
130	375
140	375
150	375
160	400
180	420
200	450

Ausführung ab Ø 225 siehe AEH2
Stutzen passend in Muffe



Abschlußelement mit Hinterlüftung AEH2	ø d	a	b
	80	375	165
	100	375	165
	113	375	165
	120	375	165
	130	375	185
	140	375	205
	150	375	205
	160	400	205
	180	420	255
	200	450	255
	225	470	300
	250	500	325
	300	540	375
	350	600	425
	400	640	475
	450	700	525
	500	740	575
	600	840	675

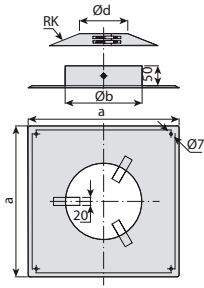

Abströmkopf AK	ø d	a
	80	130
	100	150
	113	180
	120	200
	130	200
	140	200
	150	210
	160	250
	180	260
	200	290
	225	300
	250	320
	300	340
	350	370
	400	410
	450	470
	500	520
	600	620

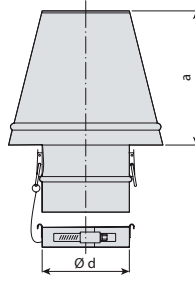

Regenhaube RH	ø d	a	ø b
	80	52	160
	100	65	200
	113	73	226
	120	78	240
	130	85	260
	140	91	280
	150	98	300
	160	160	360
	180	180	380
	200	200	400
	225	200	425
	250	250	450
	300	300	500
	350	350	550
	400	400	600
	450	450	650
	500	500	700
	600	600	800

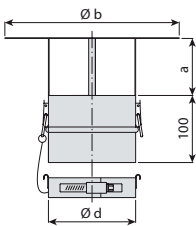

ab ø 160 sind die Stützen der RH schräg angeordnet

Abstandshalter AH	ø d
	80
	100
	113
	120
	130
	140
	150
	160
	180
	200
	225
	250
	300
	350
	400
	450
	500
	600

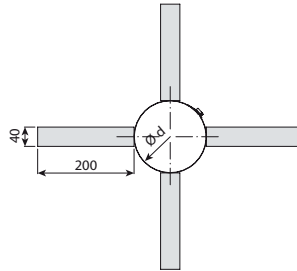

Abstandshalter für Formteile AHF	ø d
	80
	100
	113
	120
	130
	140
	150
	160
	180
	200
	225
	250
	300
	350
	400
	450
	500
	600

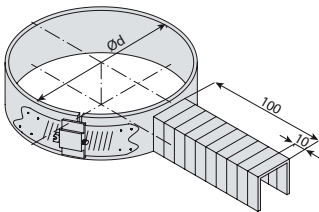

Wandhalter W	ø d	a	b
	80	110	150
	100	120	160
	113	130	170
	120	130	170
	130	140	180
	140	150	190
	150	160	200
	160	170	210
	180	180	220
	200	190	230
	225	215	255
	250	250	290
	300	300	340
	350	350	390
	400	400	440
	450	450	490
	500	500	540
	600	600	640

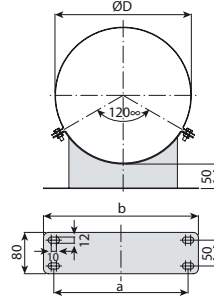

Zwischenstütze ZS	ø d	a
	80	330
	100	350
	113	363
	120	370
	130	380
	140	390
	150	400
	160	410
	180	430
	200	450
	225	450
	250	500
	300	550
	350	600
	400	650
	450	700
	500	750
	600	800

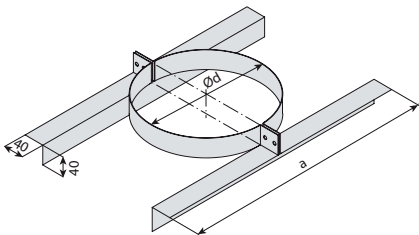

Mauerschelle MS	ø d
	80
	100
	113
	120
	130
	140
	150
	160
	180
	200
	225
	250
	300
	350
	400
	450
	500
	600

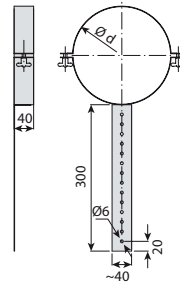

**Wärmedämmrohr
WD**

*mit Alukaschierung bis Ø 250 Lieferbar

$s = 15 \text{ mm}^*$
25 mm
50 mm

andere Dicken auf Anfrage

Ø d
113
120
130
140
150
160
180
200
225
250
300
350
400
450
500
600

**Einzeldichtung
ED**

ab Ø 350 werkseitig eingeklebt, geprüft für max. Temperatur 200° C

Ø d
80
100
113
120
130
140
150
160
180
200
225
250
300
350
400
450
500
600

Bauteile für Verbindungsleitung / Bogen / Schrägführung

**Kesselanschlusselement
KAE**

**Reduzierung/Erweiterung
RZ**

Reduzierung über 20 mm - stufige Ausführung

Bitte Nennweiten angeben

**Längenelement mit Meßöffnung
LM**

Ø d
80
100
113
120
130
140
150
160
180
200
225
250
300
350
400
450
500
600

**Längenausgleichselement
LA**

Ø d
80
100
113
120
130
140
150
160
180
200
225
250
300
350
400
450
500
600

**Bogen 15°, 30° und 45°
B15 B30 B45**

Ø d	15° a	30° a	45° a
80	98	103	109
100	99	106	113
113	100	108	116
120	100	109	118
130	101	110	120
140	102	111	122
150	102	113	124
160	103	114	126
180	104	117	130
200	106	119	134
225	107	123	139
250	109	126	144
300	112	133	155
350	116	139	165
400	119	146	175
450	122	153	186
500	125	160	196
600	132	173	217

**Bogen 45° mit Prüföffnung
BP45**

Ø d	a	Ø c
80	217	80
100	221	100
113	223	113
120	225	120
130	227	130
140	229	140
150	231	150
160	233	150
180	237	150
200	241	150
225	271	150
250	302	150
300	312	150
350	322	150
400	333	150
450	343	150
500	354	150
600	374	150



Bogen 90° B90	ø d	a	b
	80	108	172
	100	112	182
	113	116	214
	120	118	214
	130	120	214
	140	122	225
	150	124	225
	160	126	225
	180	130	225
	200	134	232
	225	139	244
	250	144	257
	300	155	282
	350	165	307
	400	176	332
	450	186	357
	500	196	382
	600	217	432

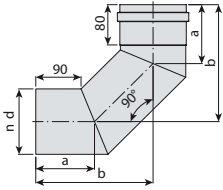

Bogen 93° B93	ø d	a	b
	80	108	172
	100	112	182
	113	116	214
	120	118	214
	130	120	214
	140	122	225
	150	124	225
	160	126	225
	180	130	225
	200	134	232
	225	139	244
	250	144	257
	300	155	282
	350	165	307
	400	176	332
	450	186	357
	500	196	382
	600	217	432

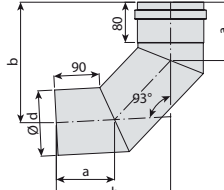

Bogen 90° dreiteilig mit Prüföffnung BP90	ø d	a	b
	80	108	174
	100	112	184
	113	116	216
	120	117	216
	130	120	216
	140	122	226
	150	124	226
	160	126	226
	180	130	226
	200	134	232
	225	139	244
	250	144	257
	300	155	282
	350	165	307
	400	176	332
	450	186	357
	500	196	382
	600	217	432

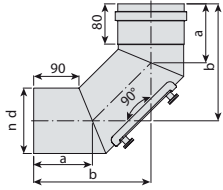

mit runden Deckel / Stutzen ab ø 250
und in ø 80

Bogen 93° mit Prüföffnung BP93	ø d	a	b
	80	108	174
	100	112	184
	113	116	216
	120	117	216
	130	120	216
	140	122	226
	150	124	226
	160	126	226
	180	130	226
	200	134	232
	225	139	244
	250	144	257
	300	155	282
	350	165	307
	400	176	332
	450	186	357
	500	196	382
	600	217	432

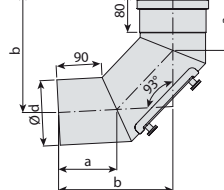

mit runden Deckel ab ø 250
und in ø 80

Bogen 93° mit Stützfuß B93S	ø d	a	b
	80	108	172
	100	112	182
	113	116	214
	120	118	214
	130	120	214
	140	122	226
	150	124	226
	160	126	226
	180	130	226
	200	134	232
	225	139	244
	250	144	257
	300	155	282
	350	165	307
	400	176	332
	450	186	357
	500	196	382
	600	217	432

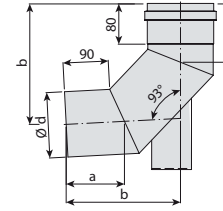

Auflageschiene AS

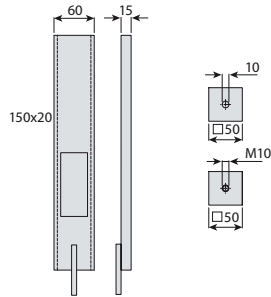

Verstellbogen 0-33° VB30	ø d	ø d
	113	125
	120	126
	130	127
	140	129
	150	130
	160	131
	180	134
	200	137
	225	140
	250	143
	300	150
	350	157
	400	164
	450	166
	500	173

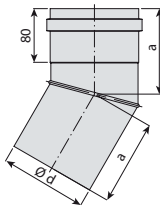

Verstellbogen 0-90° VB90	ø d	a	b	c
	113	113	182	50
	120	114	185	52
	130	115	190	55
	140	117	195	58
	150	117	197	60
	160	121	275	113
	180	124	285	118
	200	127	295	124
	225	130	310	128
	250	133	320	137
	300	140	345	150
	350	147	370	164
	400	154	395	177
	450	166	427	191
	500	173	452	205

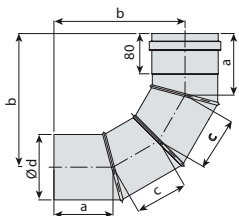

Verstellbogen 0-90° mit Prüföffnung VBP90

ø d	a	b	c
113	113	182	50
120	114	185	52
130	115	190	55
140	117	195	58
150	117	197	60
160	121	275	113
180	124	285	118
200	127	295	124
225	130	310	128
250	133	320	137
300	140	345	150
350	147	370	164
400	154	395	177
450	166	427	191
500	173	452	205

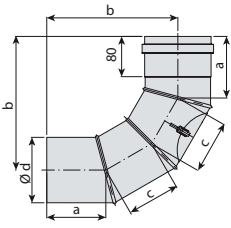

Verstellbogen 0-33° kondensat- und druckdicht VBB30

ø d	ø d
113	125
120	126
130	127
150	130
180	134
200	137

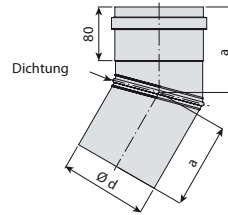

Verstellbogen 0-90° kondensat- und druckdicht VBB90

ø d	a	b	c
113	120	263	105
120	121	267	107
130	122	272	110
150	125	282	115
180	125	285	118
200	127	295	124

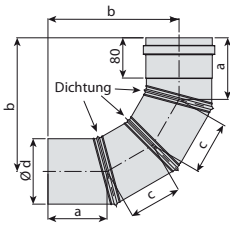

Verstellbogen 0-90° mit Prüföffnung, kondensat- und druckdicht VBPB90

ø d	a	b	c
113	120	263	105
120	121	267	107
130	122	272	110
150	125	282	115
180	125	285	118
200	127	295	124

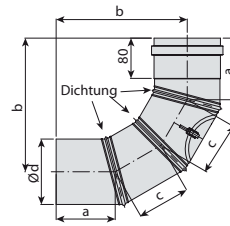

Verstellbogen 0-45° Ausführung Schweiz VB45CH

ø d	a	b	c
80	117		
100	121		
130	127		
150	131		
180	137		
200	141		

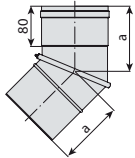

Verstellbogen 0-90° Ausführung Schweiz VB90CH

ø d	a	b	c
80	118	203	120
100	122	202	113
130	128	209	114
150	132	231	139
180	138	246	152
200	143	241	140

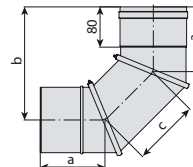

Verstellbogen 0-90° mit Reinigung, Ausführung Schweiz VBP90CH

ø d	a	b	c
80	118	203	120
100	122	202	113
130	128	209	114
150	132	231	139
180	138	246	152
200	143	241	140

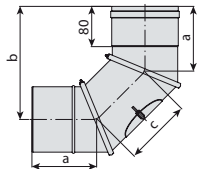

Stützfuß SP

ø d
80
100
113
120
130
140
150
160
180
200
225
250
300
350
400
450
500
600

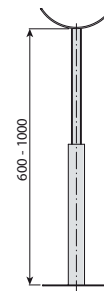

Dichtungssatz für VB30/90		ø b
VBD30/90		113
		120
		130
		150
		180
		200

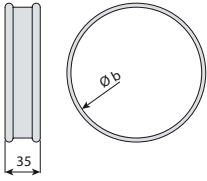

Blinddeckel		ø d
BD BF BFVIT		80
		100
		113
		120
		130
		140
		150
		160
		180
		200

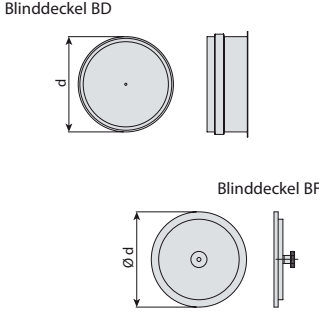

Blitzschutzklemme		ø d
BK		80
		100
		113
		120
		130
		140
		150
		160
		180
		200
		225
		250
		300
		350
		400
		450
		500
		600



Halteschelle		ø d
Abhängung HA		80
		100
		113
		120
		130
		140
		150
		160
		180
		200
		225
		250
		300
		350
		400
		450
		500
		600

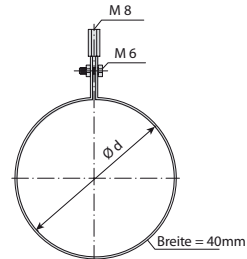

Kaskaden Zusatzteile

Kondensatablaufelement KA		ø d
Kondensatablaufelement für senkrechten		80
Einbau KA2		100
		113
		120
		130
		140
		150
		160
		180
		200
		225
		250
		300
		350
		400
		450
		500
		600

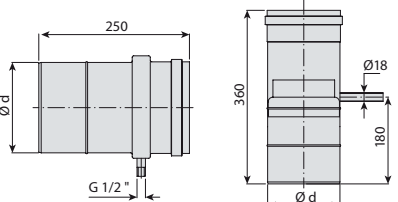

Bogen 45° Ø 80		ø d
KB45/80		80
		100
		113
		120
		130
		140
		150
		160
		180
		200
		225
		250
		300
		350
		400
		450
		500
		600

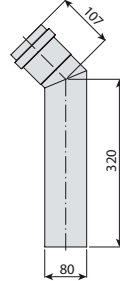

Feuerungsanschluß 45°		ø d
KF45		130
		140
		150
		160
		180
		200
		225
		250

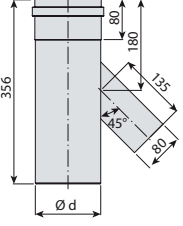

Kondensatablaufelement mit Deckel		ø d
KKA		130
		140
		150
		160
		180
		200
		225
		250

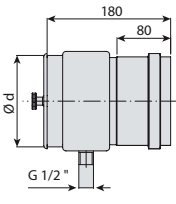

Alternative: Deckel mit Vitondichtung
Art.-Nr.: 2400-Ø-KKAVIT Art.-Nr.: 2410-Ø-KKAVIT

LAS - Zusatzteile

Prüföffnung mit Überströmöffnung PÜ		ø d	a	b	c
		100	356	178	100
		113	356	178	113
		120	356	178	120
		130	356	178	130
		140	356	178	140
		150	356	178	150
		160	356	178	160
		180	356	178	180
		200	356	178	200
		225	356	178	150
		250	500	250	180
		300	500	250	180

Feuerungsanschluß einzügig F1		ø d
		80
		100
		113
		120
		130
		140
		150
		160
		180
		200
		225
		250
		300

Bitte Maße a, b angeben
Abzweig nach Vorgabe Kesselhersteller

Feuerungsanschluß zweizügig F2		ø d
		80
		100
		113
		120
		130
		140
		150
		160
		180
		200
		225
		250
		300

Bitte Maße a, b angeben
Abzweig nach Vorgabe Kesselhersteller

Abschlußelement mit Hinterlüftung als Luftschaftabdeckung AEHL	

Luftrohr L3		ø d
		60
		63
		80
		100

Abzweig nach Vorgabe Kesselhersteller

Flexibles Edelstahl- System doppellagig / einlagig

Flexrohr einlagig FEL / Flexrohr doppellagig FDL FEL / FDL		Ø
		100
		113
		120
		130
		140
		150
		160
		180
		200

Adapter starr-flex FASF / FASF DL		Ø
		100
		113
		120
		130
		140
		150
		160
		180
		200



Adapter flex-starr
FAFS / FAFSDL

Ø
100
113
120
130
140
150
160
180
200

Adapter flex-starr für eka-flex FEL, FAFS

Adapter flex-starr für eka-flex FDL, FAFSDL

Adapter flex-flex
FAFF / FAFFDL

Ø
100
113
120
130
140
150
160
180
200

Adapter flex-flex für eka-flex FEL, FAFF

Adapter flex-flex für eka-flex FDL, FAFFDL

Abstandshalter für eka-flex
FAH

Ø
100
113
120
130
140
150
160
180
200

Für ein- und doppelartig verwendbar.

Montagesonde für eka-flex
FMS

Ø
100
113
120
130
140
150
160
180
200

Für ein- und doppelartig verwendbar.

Zubehör

Edelstahltür
12/18, 14/20, 15/30, 20/30
ES12 ES14 ES15 ES 20

Edelstahltür Lüftung
12/18, 14/20, 15/30, 20/30
EL12 EL14 EL15 EL20

ø d
80
100
113
120
130
140
150
160
180
200
250
300
350
400
450
500
600

Edelstahltür mit Putzrahmen
12/18, 14/20, 15/30, 20/30
ESP12 ESP14 ESP15 ESP20

a	b
120	180
140	200
150	300
200	300

Edelstahltür mit Schiebbestutzen
SES12 SES14 SES15

a	b
120	180
140	200
150	300
200	300

Schiebestutzen 3° Neigung



Schachteintrittsgitter 15 x 15 cm
SE

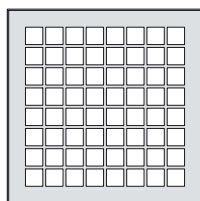

Schiebestützen 12/18, 14/20, 15/30
S12 S14 S15

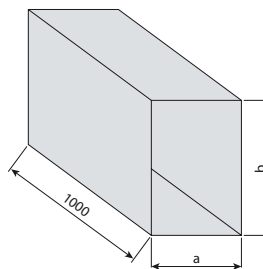

a	b
120	180
140	200
150	300
200	300

Winkelsiphon
WSD

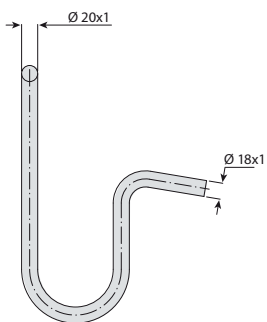

Diffusionssperre für Prüföffnung
Hochtemperatur Diffu12 Diffu14
Diffu15

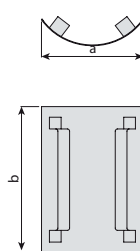

ø d	a x b		
	12x18	14x20	15x30
113	x	x	-
120	x	x	-
130	x	x	-
140	x	x	-
150	x	x	x
160	x	x	x
180	x	x	x
200	x	x	x
250	x	x	x
300	x	x	x
350	x	x	x
400	x	x	x
450	x	x	x
500	x	x	x
600	x	x	x

Diffusionssperre für Prüföffnung
Hochtemperatur, isoliert Diffu12
WD Diffu14 WD Diffu15 WD

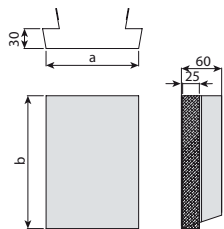

ø d	a x b		
	12x18	14x20	15x30
113	x	x	-
120	x	x	-
130	x	x	-
140	x	x	-
150	x	x	x
160	x	x	x
180	x	x	x
200	x	x	x
250	x	x	x
300	x	x	x
350	x	x	x
400	x	x	x
450	x	x	x
500	x	x	x
600	x	x	x

Regenkragen
RK

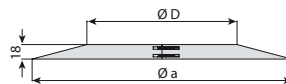

ø d	D	ø a
113	213	369
130	230	386
150	250	406
160	260	416
180	280	436
200	300	456
250	350	506
300	400	556
350	450	606
400	500	656
450	550	706
500	600	756
600	700	856

Adapter oval/rund
AOR

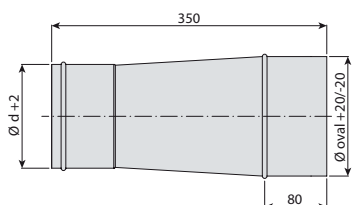

ø d
113
120
130
140
150
160
180
200
225
250

Adapter rund/oval
ARO

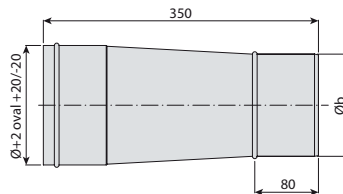

ø d
113
120
130
140
150
160
180
200
225
250



Abgasschalldämpfer 15dB
AGS15

ø a	b	c	d
113	250	360	580
120	250	360	580
130	250	360	580
150	300	360	580
160	300	360	580
180	450	540	760
200	450	540	760
250	500	540	760
300	500	540	760

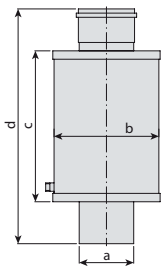

Abgasschalldämpfer 25dB
AGS25

ø a	b	c	d
113	250	720	940
120	250	720	940
130	250	720	940
150	250	720	940
160	250	720	940
180	450	900	1120
200	450	900	1120
350	500	900	1120
300	500	900	1120

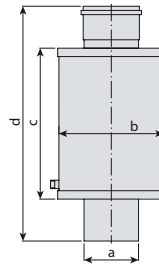

Doppelrohrsystem

Kesselanschlußelement
KAE

ø d	ø D
80	130
100	150

nach Angabe
Kesselhersteller

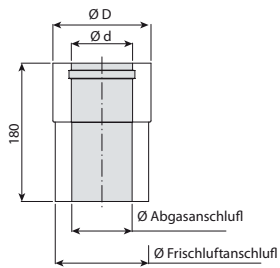

Doppelrohrsystem Feuerungsanschluß 90°
F90

ø d	ø D
80	130
100	150

Blind-
deckel BF
erforderlich!

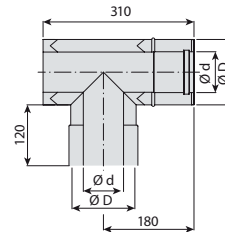

Doppelrohrsystem Längenelement
mit Meßstutzen
LM

ø d	ø D
80	130
100	150

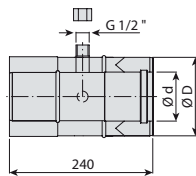

Doppelrohrsystem
Längenelement 1080 mm
L10

ø d	ø D
80	130
100	150

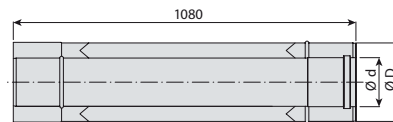

Doppelrohrsystem
Längenelement 540 mm
L5

ø d	ø D
80	130
100	150

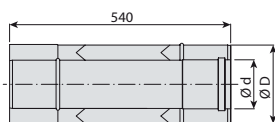

Doppelrohrsystem Längenelement
mit Doppelmuffe
LD

ø d	ø D
80	130
100	150

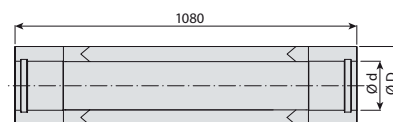

kürzbar



Doppelrohrsystem Längenausgleichselement LA	ø d	ø D
	80	130
	100	150

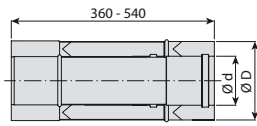

Doppelrohrsystem Bogen 90° mit Luftschlitze B90L	ø d	ø D	a
	80	130	225
	100	150	235

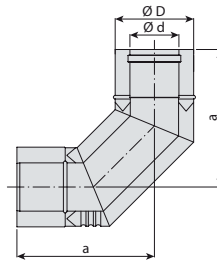

Doppelrohrsystem Bogen 90° ohne Luftschlitze B90	ø d	ø D	a
	80	130	225
	100	150	235

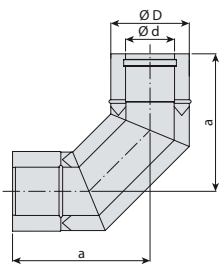

Doppelrohrsystem Wandkonsole WK	ø d	ø D	a	b
	80	130	260	280
	100	150	290	300

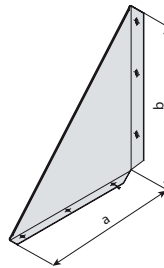

Wandabstand 100 mm

Doppelrohrsystem Wandkonsolen- verlängerung starr 100mm, 150mm, 200mm WKS10 WKS15 WKS20	ø d	ø D	a	b
	80	130	100	280
			150	
			200	

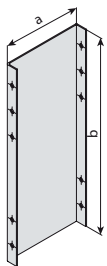

	100	150	100	300
			150	
			200	

Doppelrohrsystem Bodenplatte für Zwischenstütze geschlossen BPZ	ø d	ø D
	80	130
	100	150

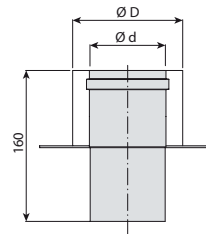

Doppelrohrsystem Bodenplatte für Zwischenstütze offen BPZO	ø d	ø D
	80	130
	100	150

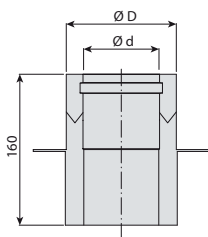

Doppelrohrsystem Prüföffnung P	ø d	ø D
	80	130
	100	150

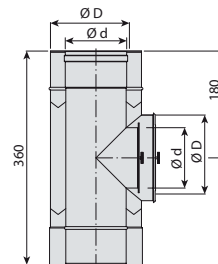

Doppelrohrsystem
Wandhalter starr 100 mm
W

ø d	ø D	a	b
a = 100, 150, 200			
80	130	140	180
100	150	150	200

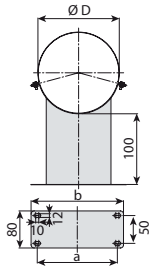

Wandabstand 100 mm

Doppelrohrsystem
Wandhalter-
verlängerung starr
100 mm,
150 mm, 200 mm
WS10 WS15 WS20

ø d	ø D	b	c
a = 100, 150, 200			
80	130	180	130
100	150	200	150

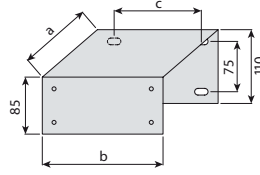

Doppelrohrsystem
Abströmkopf geschlossen
AK

ø d	ø D
80	130
100	150

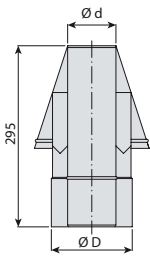

Doppelrohrsystem
Abströmkopf offen
AKO

ø d	ø D
80	130
100	150

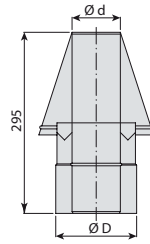

Doppelrohrsystem
Dachdurchführung flach
DF

ø d	ø D	ø a	b
80	130	160	628
100	150	180	648

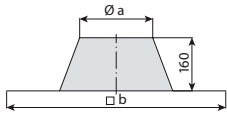

verwendbar von 0-10°
Grundplatte auch aus
Blei erhältlich

Doppelrohrsystem
Dachdurchführung mit
Blei 22° DGB22

ø d	ø D	ø a	b	c
80	130	160	640	710
100	150	180	665	740

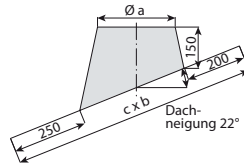

verwendbar von 10-28°
Grundplatte auch aus
Edelstahl erhältlich

Doppelrohrsystem
Dachdurchführung mit
Blei 32° DGB32

ø d	ø D	ø a	b	c
80	130	160	650	750
100	150	180	670	850

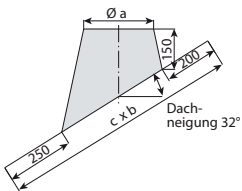

verwendbar von 28-38°
Grundplatte auch aus
Edelstahl erhältlich

Doppelrohrsystem
Dachdurchführung mit
Blei 45° DGB45

ø d	ø D	ø a	b	c
80	130	160	670	850
100	150	180	690	880

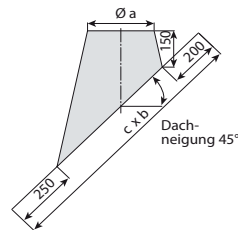

verwendbar von 38-52°
Grundplatte auch aus
Edelstahl erhältlich



**Doppelrohrsystem Regenkragen
RK**

ø d	ø D	ø a
80	130	286
100	150	306

**Doppelrohrsystem Bogen 15°
B15**

ø d	ø D	a
80	130	116
100	150	121

**Doppelrohrsystem Bogen 45°
B45**

ø d	ø D	a
80	130	117
100	150	121

**Doppelrohrsystem
Brandschutzdurchführung
BS**

ø d	ø D	ø a	b
80	130	160	360
100	150	180	380

FeuVO beachten

**Doppelrohrsystem Bogen 30°
B30**

ø d	ø D	a
80	130	117
100	150	121

**Blinddeckel Doppelrohrsystem
BF**

d	D
80	130
100	150

Für Feuerungsanschluß 90°
F90 erforderlich

